

Origami House #2

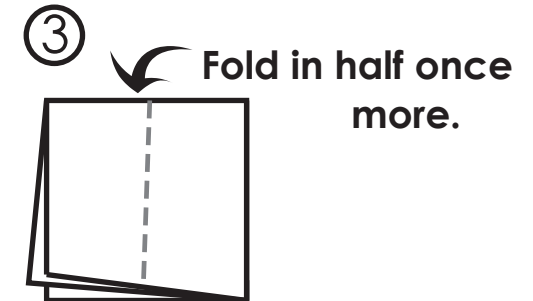

④ Unfold so you have 4 quarters created.

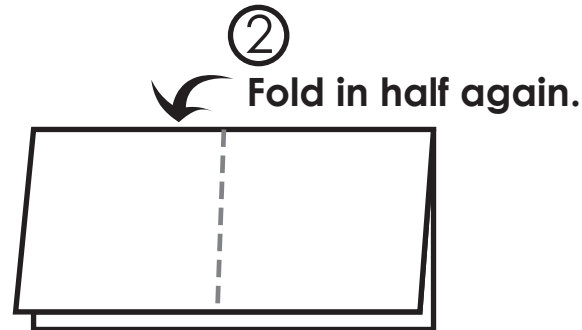
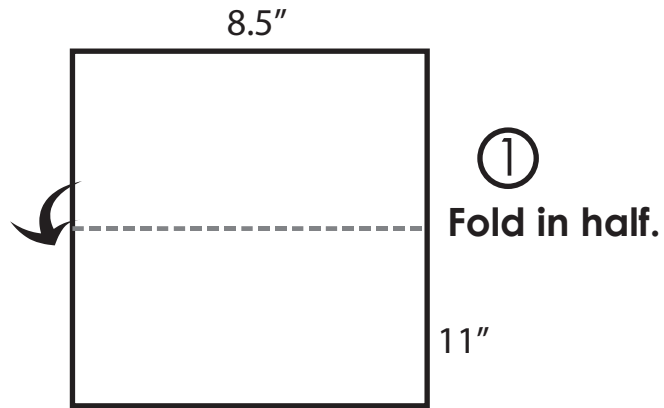
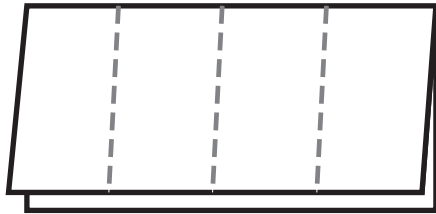

⑤ One at a time, fold each end up and press the corner down until it forms a triangle. This is the roof.



⑥ Do this to both ends.

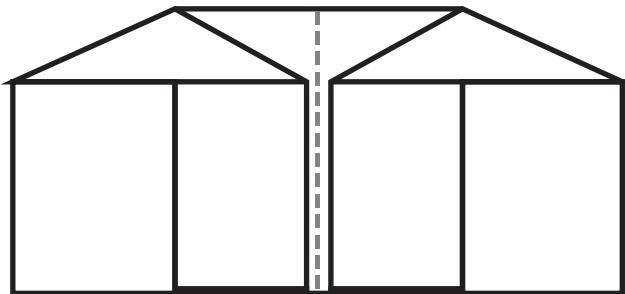
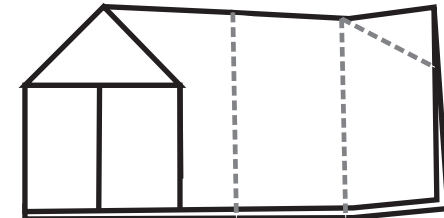

⑦ You should have a folded house!

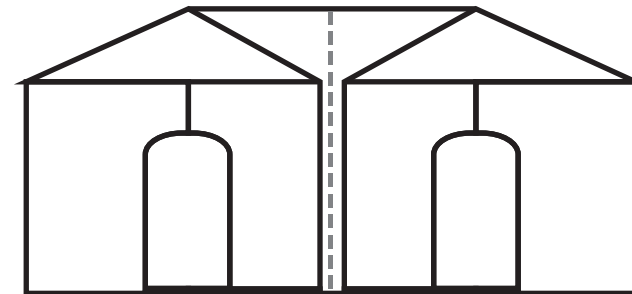

⑧ Now, add doors, window and architecture elements of your choice.



**Cut this page out
to make your own!**

Origami House #2